



# Cellferno

## M600/M1200

LTE Outdoor CPE

**USER GUIDE**



---

# Table of Contents

<b>Product Overview</b> .....	<b>4</b>
Features.....	4
Package Contents.....	4
Hardware Overview.....	5
<b>Installation</b> .....	<b>7</b>
Notice before installation.....	7
Important Installation Considerations.....	8
Mounting the Unit.....	9
Ground the CPE .....	9
Making the Connections .....	10
Connect the Ethernet Cable to the Unit .....	10
Connect the Ethernet Cable to Computers .....	11
<b>Using Web-based Management</b> .....	<b>12</b>
Status.....	14
System Information .....	16
System .....	17
Wired LAN Port Settings .....	17
DHCP Clients.....	17
Log.....	19
Mobile Information .....	20
Network Settings .....	20
LAN-side IP Address .....	21
LAN-side IP Address .....	22
DHCP Server .....	22
LAN Port .....	24
WAN Settings.....	24
Dynamic IP.....	25
Static IP .....	25
WAN Status.....	26
Enable .....	26
DMZ.....	27
Enable DMZ .....	27
Add DMZ.....	28
DMZ Table.....	28
Dos .....	29
Advanced Denial of Service Features .....	29
Access Control.....	30
Enable/Disable MAC Filter .....	31
Add MAC Filter.....	31
MAC Filter Table .....	31
Enable IP Filtering Table.....	32
IP Filter Table .....	32
URL Filter.....	34
Security Filter .....	34
Enable .....	35

Port Forwarding.....	36
Enable Port Forwarding.....	36
Add Port Rule.....	37
Port Forwarding Table.....	37
Visual Server.....	38
Visual Server Table.....	39
Special Application.....	39
Enable Trigger Port.....	40
Add Trigger Port.....	40
Trigger Port Table.....	41
ALG.....	42
UPnP.....	42
Dynamic DNS.....	43
Remote Access.....	44
WWAN Setting.....	45
Network Setting.....	45
APN Information.....	46
APN Profile Settings.....	47
APN Profile Table.....	47
UICC/SIM PIN Management.....	48
USIM Status.....	48
USIM's PIN Management.....	48
SIM Management.....	49
Preferred Network.....	49
AT Command.....	50
Management.....	51
Admin.....	52
Account to Manage This Device.....	52
Advanced Settings.....	53
Date and Time.....	53
Date and Time Settings.....	54
NTP Time Server.....	54
Time Zone.....	54
Syslog Server.....	55
Advanced.....	56
Update Firmware.....	57
Firmware Location.....	57
Update Firmware from PC.....	57
Save/Restore Settings.....	58
Save/Restore Method.....	58
Save Settings to PC.....	59
Restore Settings from PC.....	59
Factory Default.....	60
Reboot.....	60
Help.....	60
<b>Appendix A: FAQ.....</b>	<b>61</b>
<b>Appendix B: Specifications.....</b>	<b>63</b>
<b>Appendix C: Antenna Gain.....</b>	<b>66</b>

---

<b>Appendix C: Important Safety Information and Glossary .....</b>	<b>67</b>
Europe – EU Declaration of Conformity .....	67
Federal Communication Commission Interference Statement.....	69
Glossary .....	71

---

# Product Overview

Congratulations on your purchase of the Cellferno M Series LTE Outdoor CPE. With this LTE (Long Term Evolution) CPE (which is also known as 4G CPE), you can share high speed mobile broadband connectivity in a wide range of computing environments. Before you begin using the LTE outdoor CPE, read this document to familiarize yourself with the device.

## Features

- Embedded high gain directional antenna
- IP66 protection against dust and water
- Easy configuration based on Web Interface
- Provide 5 – 10dB more coverage gain compared to indoor CPE
- Support Passive Power over Ethernet.
- Easy installation and use

## Package Contents

*The following items come with your package. If any of them is damaged or missing, please contact your retailer.*

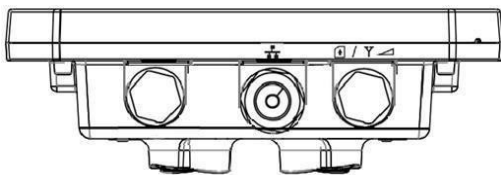

LTE Outdoor CPE

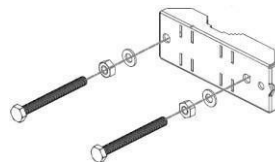

Pole Mount  
(M10\*100 Bolt, Nuts, and  
Spring Washers)



Quick Installation  
Guide



Passive PoE Adapter  
(Power over Ethernet)



Power Cord



Cap  
(For SIM card)



Nylon Cable Gland  
(For RJ-45 Ethernet  
Cable)

**Note:** The pictures are for reference only, actual items may slightly differ.

---

## Hardware Overview

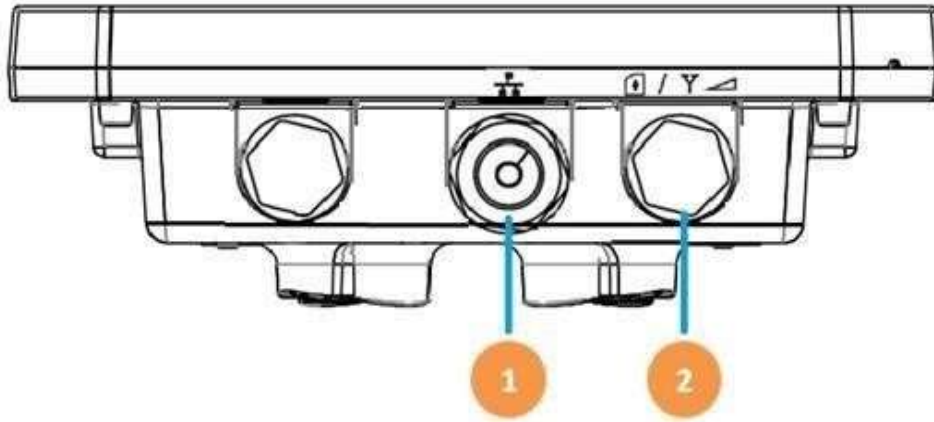

**1** Ethernet (RJ-45) port

Connect to the passive PoE adapter using an Ethernet cable.

**2** LED Indicators + SIM card slot + Reset button

LED Indicators:

The left LED indicates power status.

The right LED indicates the signal strength.

SIM card slot:

Insert the SIM card.



Reset button:

❖ Short press to restart the device.

❖ Long press for 10 seconds to reset the settings to the factory default settings.

---

The Grounding screw (marked **T**) is located on the rear panel of the ODU.

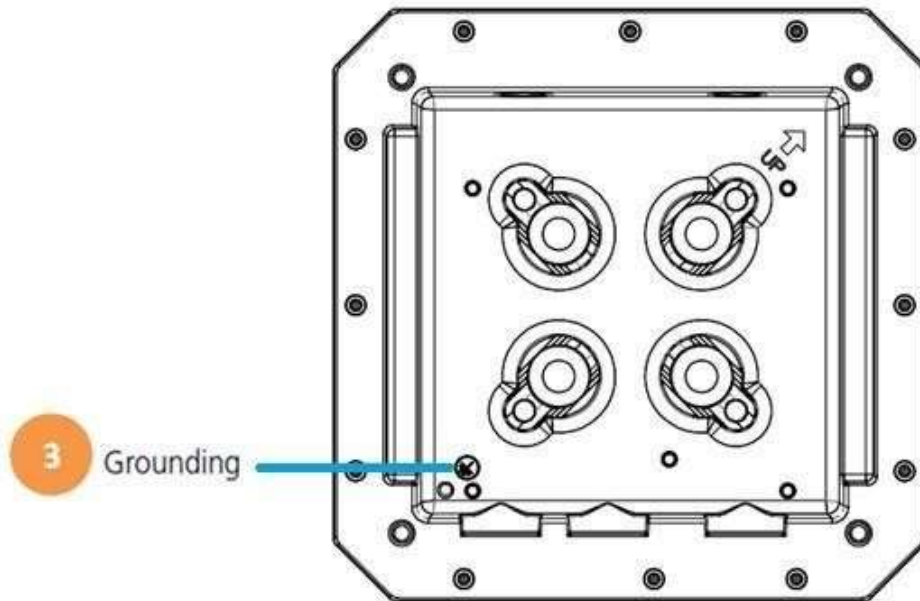

### **3** Grounding Terminal

Connect a grounding cable to the terminal and a ground connection.

#### **NOTE 1**

*Use with Ethernet lightning protector between the Ethernet cable and the PoE is suggested for better lightning and surge protection.*

#### **NOTE 2**

*For additional lightning protection, use of a lightning arrester on the Ethernet cable near the area where the Ethernet cable enters a building is suggested.*

---

# ***Installation***

## **Notice before installation**

### **Install the SIM card**

1. Unscrew the SIM card slot.
2. Insert a valid SIM card into the SIM card slot. Push it until it clicks in place.
3. Screw the cap on tightly.

### **Choose a solid and safe pole for CPE installation**

1. Choose the best location of the house and the orientation of the CPE to get the strongest signal reception from base station.
2. The ambient temperature for the CPE must be within -40°C to 65°C (-40°F to 149°F).

#### **NOTE**

For lightning protection ground the CPE via Grounding Terminal and optimum reception, there are a few things you should consider before installation. Please see “Important Installation Considerations” on page 8 for more details.

### **Prepare two Ethernet cables**

Be sure that one of the cables used is an outdoor grade CAT 5e (or above) Ethernet cable type and the length of the cables are adequate to reach the location of the CPE and indoor PPoE are.

### **Prepare wrenches**

Prepare one wrench. The wrench size: 17mm x 1.

### **Warning:**

Do NOT start any traffic test (ex: throughput test and Internet browsing) before the installer returns to the ground.



---

## Important Installation Considerations

The LTE Advanced Outdoor CPE should be pole-mounted outdoors and aligned so its antenna faces the nearest LTE eNB. Before installing the outdoor CPE, consider the appropriate location, clearance, and device orientation.

### Location and Cable wiring

1. Consult your Service Provider to find the best location and angle for getting the strongest signal from the base station.
2. Do a walking test around the house to find the best spot with the strongest signal if you don't obtain related information from Service Provider.
3. Mount the CPE at the highest possible location with a clear view of the base station signal source. Buildings or other obstructions will affect the quality of the signal you receive.
4. Keep the best distance as possible from other devices that may cause interference.
5. Keep the LTE Advanced Outdoor CPE away from power lines.
6. Avoid placing LTE Advanced Outdoor CPE too close to any metallic reflective surfaces.
7. Disconnect the power cord first before mounting the CPE. Otherwise this may result in personal injury due to electric shock.
8. Be sure to ground LTE Advanced Outdoor CPE with an appropriate grounding wire (not included) by attaching it to the grounding screw on the unit and to a good ground connection.

---

## Mounting the Unit

Mount LTE Advanced Outdoor CPE on a 1"-4" pole using the supplied kit, or the optional tilt accessory.

### Using the clamp

1. Thread the M10\*100mm bolts through spring washers, flat washers and bracket holes.
2. With the connectors facing downwards, attach the LTE Advanced Outdoor CPE to a 1" to 4" pole.
3. Attach the bracket to the other side of the pole.
4. Thread the M10\*100mm bolts through the holes the bracket and into the LTE Advanced Outdoor CPE.

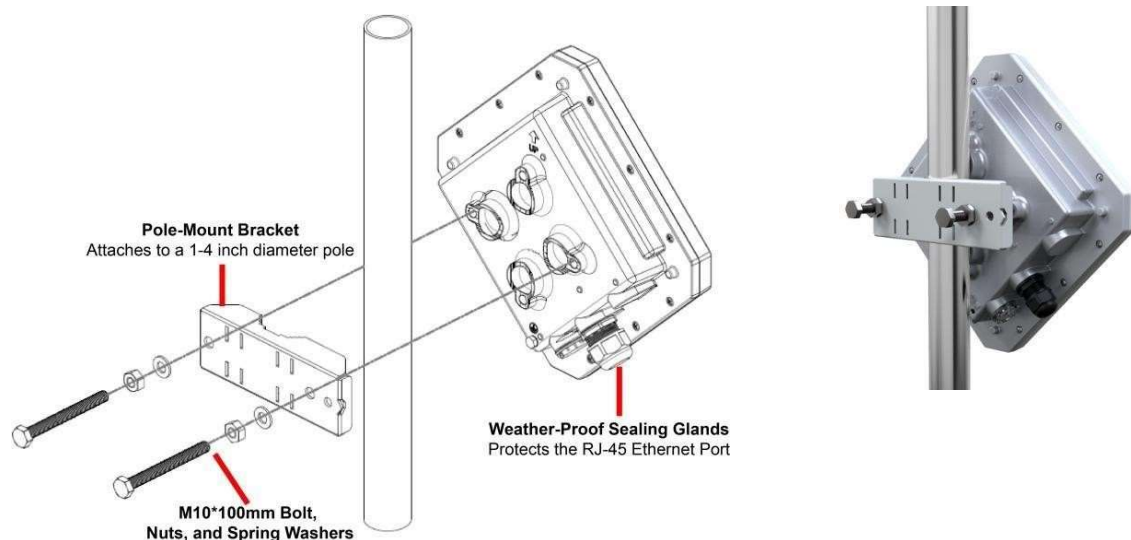

## Ground the CPE

For safe outdoor use, use the grounding terminal to ground the CPE housing before making any connections.

### You need the following:

- Spring washer
- M5x8 mm screw

### NOTE

The spring washer and M4x8L screw are not included in your package.

---

### To ground the CPE:

1. Insert the washer to the M4x8L screw.
2. Attach the screw halfway into the earth ground terminal.
3. Insert the grounding cable under the washer.
4. Tighten the screw.

## Making the Connections

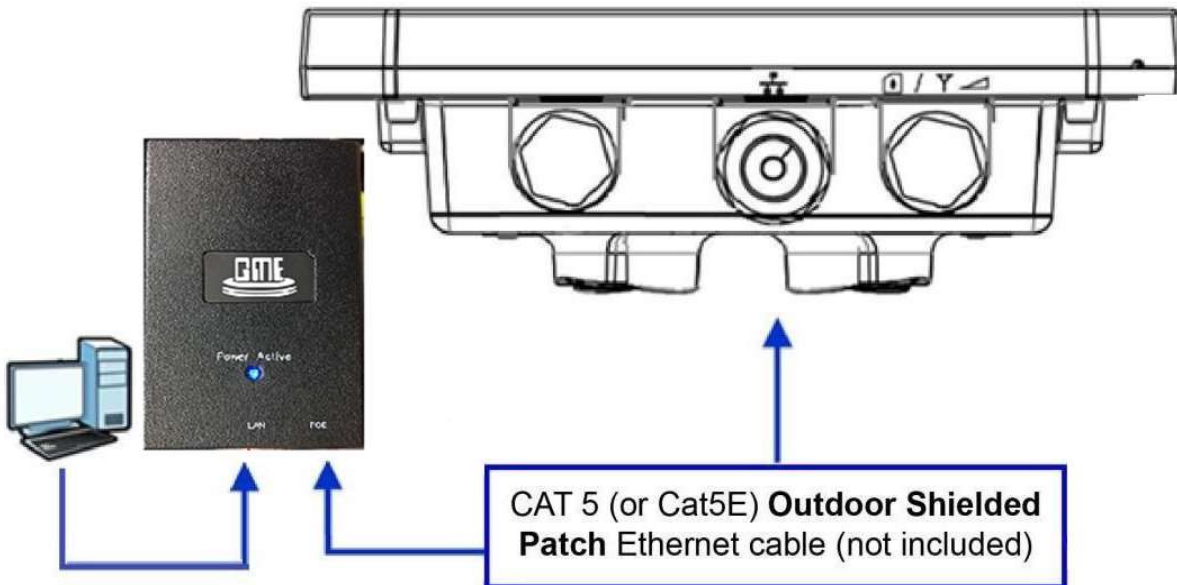

### **Connect the Ethernet Cable to the Unit**

Use only 5E 4x2x24# FTP (or above) outdoor shielded patch cables from an approved manufacturer.

1. Remove the sealing cable gland plug from the gland nut.
2. Open the sealing gland nut and remove it. Do not disassemble the gland base from the bracket.
3. Insert the Cat5 RJ-45 cable into the sealing gland base and connect it to the Ethernet port at the bottom of the unit. Make sure that the connector is completely inserted and tightened.

#### **NOTE**

*The total length of the Ethernet cable from the unit to the RJ-45 port on the PoE must not exceed 80 meters.*

4. Insert the rubber bushing on the cable into the gland base.

- 
5. Tighten the gland nut. Use the dedicated tool for fastening thesealing glands.

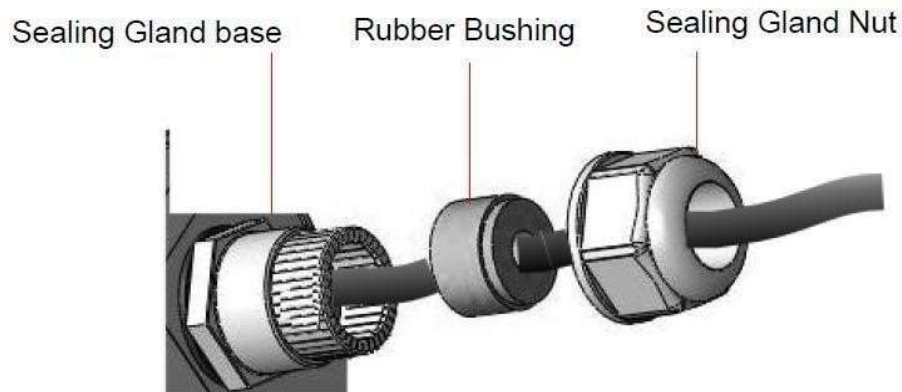

### ***Connect the Ethernet Cable to Computers***

1. After connecting the Ethernet cable to the unit, install a protective cover on the connector at the other end of the Ethernet cable.
2. Connect the Ethernet cable to the port on the PoE adapter labeled **POE**.
3. Connect another Ethernet cable to the port on the PoE adapter labeled **LAN** and the RJ-45 port on a PC/Notebook PC/Hub/Swtch.
4. Connect the PoE adapter to a power source via the power adapter/power cable.

---

# Using Web-based Management

This chapter will guide you on how to configure your CPE via the web-based utility.

## Login

1. Launch a web browser.
2. In the address bar, enter <http://192.168.2.1>, then press **Enter**.
3. In the login window, enter the username "**admin**" and password "**admin**".



4. Click **OK** to login to the main screen.
5. Click one of the menus or submenus to configure the system.

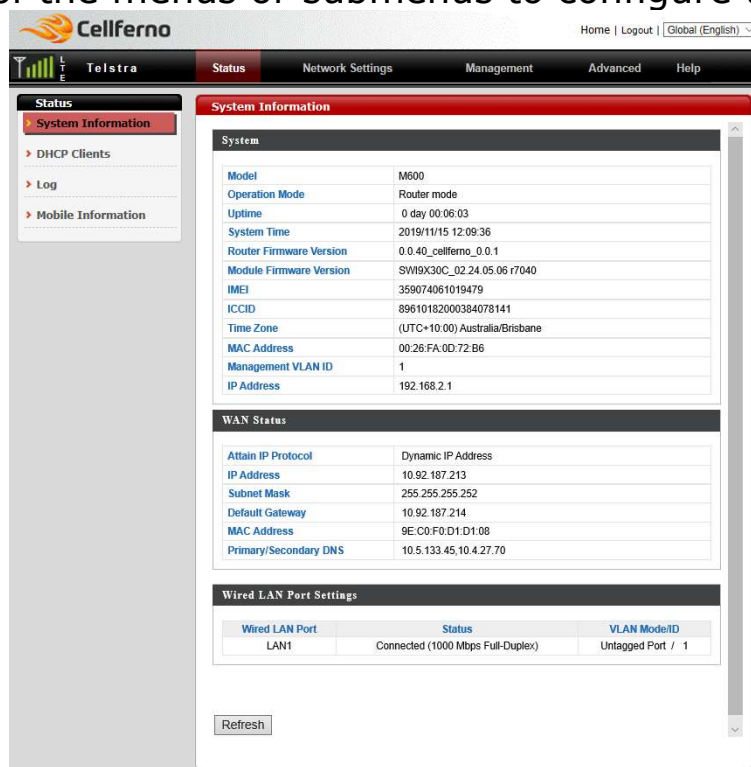

- 
- The CPE uses the network domain 192.168.2.X, for any downstream connections, all devices should avoid using this network domain otherwise there might be conflicting IP addresses which will cause communication failure.
  - If you cannot connect to the network, please follow the steps below to set the APN manually:
    1. Go to **Network Settings > WWAN Setting > APN Profile Settings** to enter the APN profile name, and then click **Add**.
    2. Enter the **APN, User Name, and Password**, and then click **Save**.
    3. Go to **Network Settings > WWAN Setting > Network Settings** and change the **APN** field to **Manual**, then select the profile name you added and click **Apply**. The changes will be applied after the system is rebooted.
  - If PIN verification on your SIM card is enabled, go to **Network Settings > Mobile Settings > UICC/SIM PIN Management** to unlock the PIN code.
  - If a SIM card is reinserted you must restart the CPE to read the SIM card properly.

# Signal Strength & Operator

The screenshot shows the Cellferno web-based management interface. At the top left, there is a signal strength indicator (four bars) and the text 'LTE'. To its right is the operator name 'Telstra'. The main navigation bar includes 'Status', 'Network Settings', 'Management', 'Advanced', and 'Help'. The 'Status' section is expanded, showing 'System Information', 'DHCP Clients', 'Log', and 'Mobile Information'. The 'System Information' section is active, displaying a table of system details.

System	
Model	M600
Operation Mode	Router mode
Uptime	0 day 00:06:53
System Time	2019/11/15 12:10:27
Router Firmware Version	0.0.40_cellferno_0.0.1
Module Firmware Version	SWI9X30C_02.24.05.06 r7040
IMEI	359074061019479
ICCID	89610182000384078141
Time Zone	(UTC+10:00) Australia/Brisbane
MAC Address	00:26:FA:0D:72:B6

On the top-left corner of the web-based management interface, the signal and operator indicator next to the menu bar demonstrates the signal strength and name of Internet service provider.

Signal Strength:

Displays signal type and signal strength.

If the mobile Internet connection is not established, **No Service** will appear.

If the mobile Internet connection is established, **3G** or **LTE** will appear based on its corresponding signal type.

Operator:

Displays the name of Internet service provider.

# Status

The screenshot shows the Cellferno router's status page. The top navigation bar includes the Cellferno logo, Telstra branding, and links for Home, Logout, and Global (English). The main navigation menu has tabs for Status, Network Settings, Management, Advanced, and Help. The left sidebar shows the Status menu with submenus for System Information, DHCP Clients, Log, and Mobile Information. The main content area is titled 'System Information' and contains three sections: System, WAN Status, and Wired LAN Port Settings. A Refresh button is located at the bottom left of the main content area.

System	
Model	M600
Operation Mode	Router mode
Uptime	0 day 00:06:03
System Time	2019/11/15 12:09:36
Router Firmware Version	0.0.40_cellferno_0.0.1
Module Firmware Version	SWI9X30C_02.24.05.06 r7040
IMEI	359074061019479
ICCID	89610182000384078141
Time Zone	(UTC+10:00) Australia/Brisbane
MAC Address	00:26:FA:0D:72:B6
Management VLAN ID	1
IP Address	192.168.2.1

WAN Status	
Attain IP Protocol	Dynamic IP Address
IP Address	10.92.187.213
Subnet Mask	255.255.255.252
Default Gateway	10.92.187.214
MAC Address	9E:C0:F0:D1:D1:08
Primary/Secondary DNS	10.5.133.45,10.4.27.70

Wired LAN Port Settings		
Wired LAN Port	Status	VLAN Mode/ID
LAN1	Connected (1000 Mbps Full-Duplex)	Untagged Port / 1

Refresh

The **Status** menu displays status information for the router. The associated submenus are: **System Information**, **DHCP Clients**, **Log**, and **Mobile Information**.



## System Information

### System Information

#### System

<b>Model</b>	M600
<b>Operation Mode</b>	Router mode
<b>Uptime</b>	0 day 00:14:56
<b>System Time</b>	2019/11/15 12:18:30
<b>Router Firmware Version</b>	0.0.40_cellferno_0.0.1
<b>Module Firmware Version</b>	SWI9X30C_02.24.05.06 r7040
<b>IMEI</b>	359074061019479
<b>ICCID</b>	89610182000384078141
<b>Time Zone</b>	(UTC+10:00) Australia/Brisbane
<b>MAC Address</b>	00:26:FA:0D:72:B6
<b>Management VLAN ID</b>	1
<b>IP Address</b>	192.168.2.1

#### WAN Status

<b>Attain IP Protocol</b>	Dynamic IP Address
<b>IP Address</b>	10.92.187.213
<b>Subnet Mask</b>	255.255.255.252
<b>Default Gateway</b>	10.92.187.214
<b>MAC Address</b>	9E:C0:F0:D1:D1:08
<b>Primary/Secondary DNS</b>	10.5.133.45,10.4.27.70

The **System Information** submenu displays general information about the router.

Click **Refresh** at the bottom of this menu to update the system information.

## System

System	
Model	M600
Operation Mode	Router mode
Uptime	0 day 00:15:43
System Time	2019/11/15 12:19:17
Router Firmware Version	0.0.40_cellferno_0.0.1
Module Firmware Version	SWI9X30C_02.24.05.06 r7040
IMEI	359074061019479
ICCID	89610182000384078141
Time Zone	(UTC+10:00) Australia/Brisbane
MAC Address	00:26:FA:0D:72:B6
Management VLAN ID	1
IP Address	192.168.2.1

This section displays system information: model, product name, uptime, system time, router firmware version, module firmware version, module IMEI, module ICCID, time zone, and mac address.

Click **Refresh** to refresh the IP address.

## Wired LAN Port Settings

Wired LAN Port Settings	
Wired LAN Port	Status
LAN1	Connected (1000 Mbps Full-Duplex)

This section displays the wired LAN port and its connection status.

## DHCP Clients

DHCP Clients		
This table shows the assigned IP address, MAC address and expiration time for each DHCP leased client.		
DHCP Client Table		
IP Address	MAC Address	Expiration Time
192.168.2.120	94:DE:80:11:58:B6	0 day 00:51:14
<input type="button" value="Refresh"/>		

---

The **DHCP Clients** submenu displays DHCP lease information for each client, including IP address, MAC address, and lease time remaining.

Click **Refresh** to update the DHCP lease information.

# Log

## Log

```
Nov 15 12:20:23 [SYSTEM]: [debug] usb0 is exist
Nov 15 12:20:18 [SYSLOG]: Do RIL_GetModemNAI
Nov 15 12:20:18 [SYSLOG]: Do RIL_GetModemPRL
Nov 15 12:20:17 [SYSTEM]: [debug] usb0 is exist
Nov 15 12:20:16 [SYSLOG]: Do RIL_GetModemNAI
Nov 15 12:20:16 [SYSLOG]: Do RIL_GetModemPRL
Nov 15 12:20:14 [SYSLOG]: Do RIL_GetModemNAI
Nov 15 12:20:14 [SYSLOG]: Do RIL_GetModemPRL
Nov 15 12:20:14 [SYSLOG]: 0428-2 [RIL_BR_CONN_ST] connst=[1,1], ret=0
Nov 15 12:20:14 [SYSLOG]: 3 pthread=-1242548944, rilc_lock=0xB6FA0AF4, pid=1052, ppid=1
Nov 15 12:20:14 [LIBRILC]: RIL_IPC_Disconnect
Nov 15 12:20:14 [LIBRILC]: [Done] br_conn_st
Nov 15 12:20:14 [LIBRILC]: br_conn_st: 1,1
Nov 15 12:20:14 [LIBRILC]: 0428-2 [request_command] resp_connst=1,1
Nov 15 12:20:14 [LIBRILC]: 0428-2 [request_command] result=br_conn_st s/1,1
Nov 15 12:20:14 [LIBRILC]: [PARSE] br_conn_st
Nov 15 12:20:14 [LIBRILC]: Command okay 0
Nov 15 12:20:14 [LIBRILC]: Process CMD Resp: Result (16): br_conn_st s/1,1
Nov 15 12:20:14 [RILD]: [RILd_TX][Done] br_conn_st
Nov 15 12:20:14 [SYSLOG]: Do RIL_BR_CONN_ST
Nov 15 12:20:14 [SYSLOG]: 3 pthread=-1242548944, rilc_lock=0xB6FA0AF4, pid=1052, ppid=1
Nov 15 12:20:13 [SYSLOG]: RIL_IPC_Disconnect
Nov 15 12:20:13 [SYSLOG]: [Done] bl.at_command
Nov 15 12:20:13 [SYSLOG]: bl.at_command: AT!GSTATUS?;!GSTATUS: ;Current Time: 993      Temperature
Nov 15 12:20:13 [SYSLOG]: [PARSE] bl.at_command
Nov 15 12:20:13 [SYSLOG]: Command okay 0
Nov 15 12:20:13 [SYSLOG]: Process CMD Resp: Result (731): bl.at_command s/AT!GSTATUS?;!GSTATUS: ;Cu
Nov 15 12:20:13 [RILD]: [RILd_TX][Done] bl.at_command
Nov 15 12:20:13 [RILD]: RILd/atril.c: FEED BACK SYS MODE 7
Nov 15 12:20:13 [RILD]: [Send2CM][Done] URC_SYSMODE
Nov 15 12:20:13 [RILD]: [Send2CM] URC_SYSMODE
Nov 15 12:20:13 [RILD]: [Send2CM] request_command: remote cmd okay 0
Nov 15 12:20:13 [RILD]: [Send2CM] cmd_handler: Result (11): URC_SYSMODE
Nov 15 12:20:13 [SYSLOG]: [Done] URC_SYSMODE
```

Save

Clear

Refresh

The **Log** submenu tracks system activities after the system is powered on.

Click **Save** to save the record of system activities.

Click **Clear** to clear the record of system activities.

Click **Refresh** to update the record of system activities.

## Mobile Information

### Mobile Information

Network	
Network	LTE
Connection Status	Registered
Roaming Status	Home Network
Cell ID	08BEFF1F
Operator Name	Telstra
PLMN	505,01
ICCID	89610182000384078141
IMSI	505013521143897
Connected Band	B7
Uplink Current Speed	12561 bps
Downlink Current Speed	7099 bps
Data Uplink / Downlink Traffic	1488 KB / 2340 KB <input type="button" value="Clear Traffic"/>
SINR	7.2
RxM RSSI	-25 dBm
RxD RSSI	-28 dBm
RSRQ	-13
RSRP	-61
PCI	381

The **Mobile Information** submenu displays detailed network statuses for the router, including network, connection status, roaming status, cell ID, operator name, PLMN, ICCID, IMSI, connected band, uplink current speed, downlink current speed, data uplink and downlink traffic, SINR, RSSI, RSRQ, RSRP, PCI, and CA state.

Click **Clear Traffic** to clear the data uplink and downlink traffic.

---

## Network Settings

The **Network Settings** menu features detailed network settings and configurations for the router. The associated submenus are: **LAN-side IP Address**, **LAN Port**, **WAN > WAN Settings**, **WAN > WAN Status**, **Firewall > Enable**, **Firewall > DMZ**, **Firewall > Dos**, **Firewall > Access Control**, **Firewall > URL Filter**, **Firewall > Security Filter**, **Advanced Settings > Enable**, **Advanced Settings > Port Forwarding**, **Advanced Settings > Virtual Server**, **Advanced Settings > Special Application**, **Advanced Settings > ALG**, **Advanced Settings > UPnP**, **Advanced Settings > Dynamic DNS**, **Advanced Settings > Remote Access**, **Mobile Internet > WWAN Setting**, **Mobile Internet > UICC/SIM PIN Management**, **Mobile Internet > SIM Management**, **Mobile Internet > Preferred Network**, and **Mobile Internet > AT Command**.

### *LAN-side IP Address*

The screenshot shows the 'LAN-side IP Address' configuration page. It is divided into two main sections: 'LAN-side IP Address' and 'DHCP Server'. The 'LAN-side IP Address' section includes fields for 'IP Address Assignment' (set to 'Static IP Address'), 'IP Address' (192.168.2.1), and 'Subnet Mask' (255.255.255.0). The 'DHCP Server' section includes fields for 'DHCP Server' (set to 'Enabled'), 'Starting IP Address' (192.168.2.120), 'Ending IP Address' (192.168.2.140), 'Domain Name' (E600), 'Lease Time' (set to 'One Hour'), 'Primary DNS' (0.0.0.0), and 'Secondary DNS' (0.0.0.0). An 'Apply' button is located at the bottom right of the page.

LAN-side IP Address	
IP Address Assignment	Static IP Address ▼
IP Address	192.168.2.1
Subnet Mask	255.255.255.0

DHCP Server	
DHCP Server	Enabled ▼
Starting IP Address	192.168.2.120
Ending IP Address	192.168.2.140
Domain Name	E600
Lease Time	One Hour ▼
Primary DNS	0.0.0.0
Secondary DNS	0.0.0.0

Apply

The **LAN-side IP Address** submenu allows users to change LAN-side IP address and DHCP server configurations.

Click **Apply** to have any changes to the configurations take effect.

---

## LAN-side IP Address

LAN-side IP Address	
IP Address Assignment	Static IP Address ▼
IP Address	192.168.2.1
Subnet Mask	255.255.255.0

**IP Address Assignment:** Select Dynamic IP Address or Static IP Address by clicking the drop-down list.

**IP Address:** Allows users to manually configure the IP address if Static IP Address is selected.

**Subnet Mask:** Allows users to manually configure subnet mask if Static IP Address is selected.

## DHCP Server

DHCP Server	
DHCP Server	Enabled ▼
Starting IP Address	192.168.2.120
Ending IP Address	192.168.2.140
Domain Name	E600
Lease Time	One Hour ▼
Primary DNS	0.0.0.0
Secondary DNS	0.0.0.0

**DHCP Server:** Click the drop-down list to enable or disable the DHCP server feature.

**Starting IP Address:** Specifies the starting number of assigned client IP address.

**Ending IP Address:** Specifies the ending number of assigned client IP address.

**Domain Name:** Specifies the Domain Name.

**Lease Time:** Specifies the amount of lease time allocated to clients of this router, i.e. the expiry time of leased addresses. Click the drop-down list to set lease time.

---

Primary DNS: Allows users to specify the primary Domain Name System if necessary.

Secondary DNS: Allows users to specify the secondary Domain Name System if necessary.



---

## LAN Port



The **LAN Port** submenu allows users to change **Wired LAN Port Settings**.

- |                 |   |
|-----------------|---|
| Wired LAN Port: | Displays the wired LAN port.  |
| Speed & Duplex: | Allows users to select router speed and data transmission method. The available options are: <i>Auto</i> , <i>10 Mbps Half-Duplex</i> , <i>10 Mbps Full-Duplex</i> , <i>100 Mbps Half-Duplex</i> , <i>100 Mbps Full-Duplex</i> , and <i>1000 Mbps Full-Duplex</i> . |
| Flow Control:   | Allows users to enable or disable Ethernet flow control.  |
| 802.3az         | Allows users to enable or disable IEEE 802.3az energy-efficient technology.   |

Click **Apply** to have any changes to the configurations take effect.

## WAN Settings

Select a Wide Area Network (WAN) connection mode and configure the settings. If you are unsure about your connection type, contact your ISP.

The screenshot shows a 'WAN Settings' dialog box with a red title bar. Inside, there is a section titled 'Dynamic IP Address'. It contains three input fields: 'Login Method' with a dropdown menu set to 'Dynamic IP Address', 'Hostname' with the text 'Generic2133', and 'MAC Address' with the text '000000000000'. To the right of the MAC Address field is a 'Clone Mac' button. At the bottom right of the dialog are 'Apply' and 'Cancel' buttons.

### Dynamic IP

Select “Dynamic IP”. If your Internet service provider assigns IP address automatically using DHCP (Dynamic Host Configuration Protocol).

<b>Host Name</b>	Enter the host name of your computer.
<b>MAC Address</b>	For some applications, you may need to designate a specific MAC address for the router. Please enter the MAC address here. If you are connecting the router to a computer, press “Clone Mac” to automatically enter your computer’s MAC address.
<b>MTU</b>	Enter the maximum transmission unit (MTU) value of your network connection. The default value is 1500.

### Static IP

Select “Static IP” if your ISP provides Internet access via a fixed IP address. Your ISP will provide you with such information as IP address, subnet mask, gateway address, and DNS address.

<b>IP Address</b>	Input the IP address assigned by your ISP here.
<b>Subnet Mask</b>	Input the subnet mask assigned by your ISP here.
<b>Default Gateway Address</b>	Input the default gateway assigned by your ISP here. Some ISPs may call this “Default Route”.
<b>DNS Address 1 &amp; 2</b>	Enter the DNS address(es) assigned by your ISP here.
<b>MTU</b>	Enter the maximum transmission unit (MTU) value of your network connection. The default value is 1500.

---

## WAN Status

The screenshot shows a window titled "WAN Status" with a red header. Inside, there is a sub-header "WAN Status" and a table of configuration items:

Attain IP Protocol	Dynamic IP Address
IP Address	10.9.165.237
Subnet Mask	255.255.255.252
Default Gateway	10.9.165.238
MAC Address	0A:A8:D0:4D:3F:08
Primary DNS	61.31.233.1,168.95.1.1

The **WAN Status** submenu displays current configurations for the WAN. The associated items are: Attain IP Protocol, IP Address, Subnet Mask, Default Gateway, MAC Address, and Primary DNS.

## Enable

The screenshot shows a window titled "Enable" with a red header. Inside, there is a sub-header "Firewall Module" and a section for "Firewall Module Function" with two radio buttons: "Enable" (selected) and "Disable". An "Apply" button is located at the bottom right.

The **Enable** submenu allows users to activate or deactivate the Firewall Module function.

Firewall Module Check Enable or Disable to enable or disable Function this feature.

Click **Apply** to have any changes to the configurations take effect.

# DMZ

The screenshot shows a web-based configuration interface for DMZ. It is divided into three main sections:

- Enable DMZ:** A section with a checkbox labeled "Enable" next to the text "DMZ".
- Add DMZ:** A section for adding a new DMZ entry. It includes:
  - Radio buttons for "Dynamic IP" (selected) and "Static IP".
  - A dropdown menu for "Dynamic IP" currently showing "Session1".
  - Input fields for "Public IP address" and "Client PC IP Address".
  - "Add" and "Reset" buttons.
- DMZ Table:** A table with the following columns: "#", "Public IP address", "Client PC IP Address", and "Select". Below the table are "Delete Selected" and "Delete All" buttons.

At the bottom right of the interface are "Apply" and "Cancel" buttons.

The **DMZ** submenu allows users to enable and configure a DMZ for their router.

When a firewall is used, it is sometimes necessary to place some clients (for example, for Internet games, video conferencing, or VPN connections) outside of the firewall while leaving the others protected. Users are allowed to do this using a Demilitarized Zone (DMZ). This DMZ feature allows users to specify the IP address of the computers that are placed outside the firewall of the network.

## Enable DMZ

This screenshot shows the "Enable DMZ" section of the configuration interface. It features a checkbox labeled "Enable" next to the text "DMZ".

DMZ: Allows users to enable or disable DMZ.

## Add DMZ

A Demilitarized Zone (**DMZ**) is an isolated area in your local network where private IP addresses are mapped to specified Internet IP addresses, allowing unrestricted access to the private IP addresses but not to the wider local network.

You can define a virtual **DMZ** host here. This is useful for example, if a network client PC cannot run an application properly from behind an NAT firewall, since it opens the client up to unrestricted two-way access.

Add DMZ	
Public IP address	<input checked="" type="radio"/> Dynamic IP <input type="radio"/> Static IP
Client PC IP Address	Session1 <input type="text"/>
<input type="button" value="Add"/> <input type="button" value="Reset"/>	
<b>Enable DMZ</b>	Check/uncheck the box to enable/disable the device's DMZ function.
<b>Add DMZ</b>	Select "Dynamic IP" or "Static IP" here.  For "Dynamic IP" select an Internet connection session from dropdown menu.  For "Static IP" enter the IP address that you want to map to a specific private IP address.
<b>Client PC</b>	Enter the private IP address that the internet IP address will be mapped to.
<b>Add</b>	Click "Add" to add the client to the "Current DMZ Table".

## DMZ Table

DMZ Table			
#	Public IP address	Client PC IP Address	Select
<input type="button" value="Delete Selected"/> <input type="button" value="Delete All"/>			

This section allows users to manage the **DMZ** host list.

To remove specific DMZ hosts, select those DMZ hosts and click **Delete Selected**. To remove all DMZ hosts, click **Delete All**.

## Dos

Denial-of-Service (**DoS**) is a common form of malicious attack against a network. The router's firewall can protect against such attacks.

If you are not familiar with these functions, it is recommended you keep the default settings.



The screenshot shows a configuration window titled "Dos" with a red header. Inside, there is a section titled "Basic Denial of Service features" with a dark background. Below this, four features are listed with checkboxes: "Ping of Death", "Discard Ping on WAN", "Port Scan", and "Sync Flood", all of which are checked. An "Advanced Settings" button is located below these features. At the bottom right of the window, there are "Apply" and "Cancel" buttons.

## Advanced Denial of Service Features

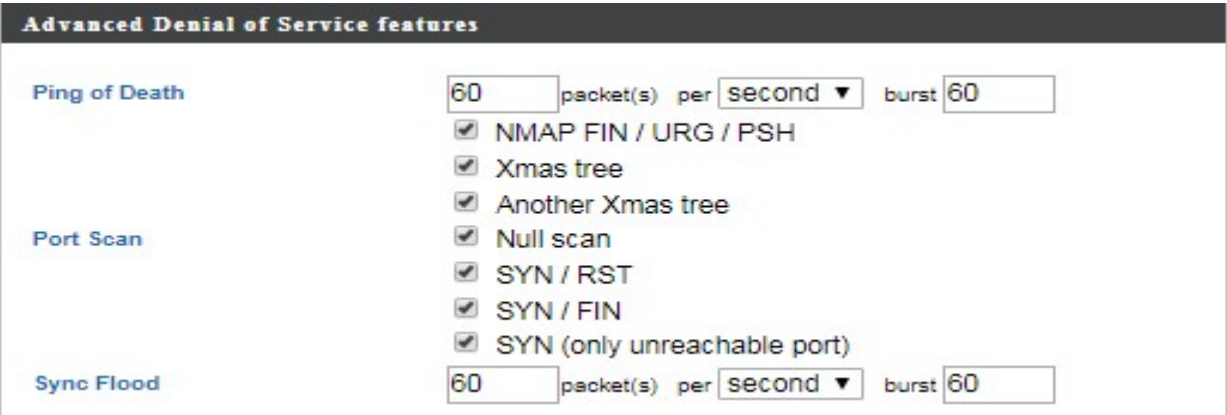

The screenshot shows a configuration window titled "Advanced Denial of Service features" with a dark header. It contains three sections: "Ping of Death", "Port Scan", and "Sync Flood". "Ping of Death" has a frequency of 60 packet(s) per second and a burst of 60, with checkboxes for NMAP FIN / URG / PSH, Xmas tree, and Another Xmas tree. "Port Scan" has checkboxes for Null scan, SYN / RST, SYN / FIN, and SYN (only unreachable port). "Sync Flood" has a frequency of 60 packet(s) per second and a burst of 60.

<b>Ping of Death</b>	Specify the frequency of ping of death packets which will trigger the router's DoS protection function.
<b>Port Scan</b>	Intruders use "port scanners" to detect open Internet IP address ports. Check each type of port scan to prevent.
<b>Sync Flood</b>	Specify the frequency of sync flood packets which will trigger the DoS protection function.

# Access Control

**Access Control**

**Enable/Disable MAC Filter**

MAC Filter  Enable

Action  Deny  Allow

**Add MAC Filter**

Client PC MAC Address

Comment

Add Reset

**MAC Filter Table**

#	Client PC Address	Comment	Select
---	-------------------	---------	--------

Delete Selected Delete All

**Enable IP Filtering Table**

IP Filter  Enable

Action  Deny  Allow

**IP Filter Table**

#	PC Description	PC IP Address	Client Service	Protocol	Port range	Select
---	----------------	---------------	----------------	----------	------------	--------

Add Delete Selected Delete All

Apply Cancel

The **Access Control** submenu allows users to filter access for the network.

---

## Enable/Disable MAC Filter



This section allows users to filter wireless connections by MAC address.  
MAC Filter: Check or uncheck to enable or disable this feature.

Action: Check **Deny** or **Allow** to deny or allow connections from MAC addresses specified in the MAC Filter Table if MAC Filter is enabled.

## Add MAC Filter

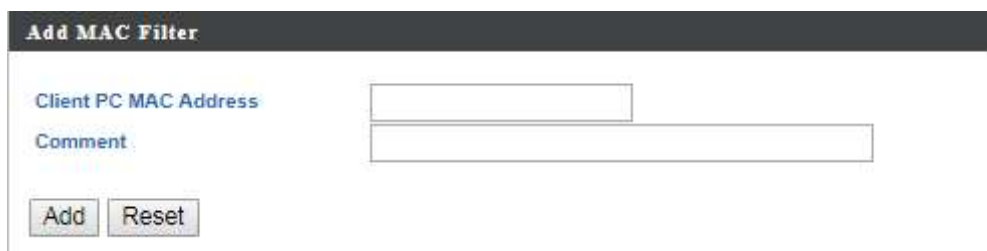

If a MAC filter is enabled, follow the instructions below for each field.

Client PC MAC Address: Enter the MAC address of a computer to be denied or allowed access in the field.

Comment: Provide a description of the filtered connection.

Click **Add** to add the MAC address filtering entry or **Reset** to redo.

## MAC Filter Table



This section allows users to manage MAC address filtering entries. All MAC address filtering entries you have created will be displayed in this table.



---

To remove specific MAC filtering entries, select those entries and click **Delete Selected**. To remove all MAC filtering entries, click **Delete All**.

## Enable IP Filtering Table



The screenshot shows a configuration window titled "Enable IP Filtering Table". It contains two sections: "IP Filter" with an unchecked checkbox labeled "Enable", and "Action" with two radio buttons: "Deny" (which is selected) and "Allow".

This section allows users to filter wireless connections by IP address.

**IP Filter:** Check or uncheck to enable or disable this feature.

**Action:** Check Deny or Allow to deny or allow connections from IP addresses specified in the IP Filter Table if IP Filter is enabled.

## IP Filter Table

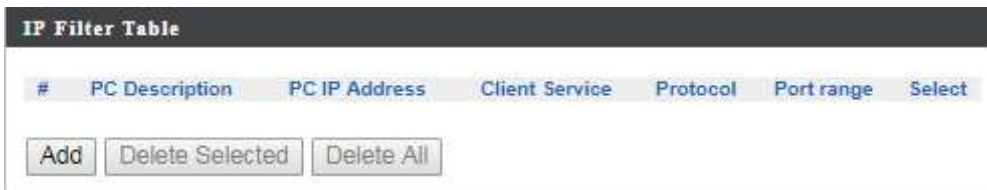

The screenshot shows a table management interface titled "IP Filter Table". The table has columns: "#", "PC Description", "PC IP Address", "Client Service", "Protocol", "Port range", and "Select". Below the table are three buttons: "Add", "Delete Selected", and "Delete All".

This section allows users to manage IP filtering entries.

To remove specific IP addresses, select those IP addresses and click **Delete Selected**. To remove all IP addresses, click **Delete All**.

To add new IP filtering entries, click **Add** and menu appears allowing the user to define the IP address that will be filtered. In the menu, follow the instructions below for each field.

This page allows users to define service limitation of client PC, including IP address and service type.

Client PC Description

Client PC IP Address  -

Client Service

Service Name	Detail Description	Select
WWW	HTTP, TCP Port 80, 3128, 8000, 8080, 8081	<input type="checkbox"/>
E-mail Sending	SMTP, TCP Port 25	<input type="checkbox"/>
News Forums	NNTP, TCP Port 119	<input type="checkbox"/>
E-mail Receiving	POP3, TCP Port 110	<input type="checkbox"/>
Secure HTTP	HTTPS, TCP Port 443	<input type="checkbox"/>
File Transfer	FTP, TCP Port 21	<input type="checkbox"/>
MSN Messenger	TCP Port 1863	<input type="checkbox"/>
Telnet Service	TCP Port 23	<input type="checkbox"/>
AIM	AOL Instant Messenger, TCP Port 5190	<input type="checkbox"/>
NetMeeting	H.323, TCP Port 389,522,1503,1720,1731	<input type="checkbox"/>
DNS	UDP Port 53	<input type="checkbox"/>
SNMP	UDP Port 161, 162	<input type="checkbox"/>
VPN-PPTP	TCP Port 1723	<input type="checkbox"/>
VPN-L2TP	UDP Port 1701	<input type="checkbox"/>
TCP	All TCP Port	<input type="checkbox"/>
UDP	All UDP Port	<input type="checkbox"/>

User Define Service  
Protocol

Port Range  ~

- Client PC Description: Provide a description of client computer.
- Client PC IP Address: Enter an IP address range for the computers to be denied or allowed access.
- Client Service: Check or uncheck to authorize or un-authorize client computer to use specific services through the network.
- Protocol: Click the drop-down list to select a protocol. The available options are: *Both*, *TCP*, and *UDP*.
- Port Range: Enter the port range for the computers to be denied or allowed access.
- Click **Add** to add a new IP filtering entry or **Reset** to redo configurations.

---

## URL Filter

The “Firewall” menu provides access to **URL** blocking functions to improve the security of your wireless network.

The screenshot shows the 'URL Filter' configuration window. It has a red title bar with the text 'URL Filter'. The main content area is divided into three sections:

- Enable URL Blocking:** A dark header bar. Below it, the text 'URL Blocking' is followed by an unchecked checkbox labeled 'Enable'.
- Add Blocking URL:** A dark header bar. Below it, the text 'URL/Keyword' is followed by an empty text input field. Below the input field are two buttons: 'Add' and 'Reset'.
- URL Blocking Table:** A dark header bar. Below it, there is a table with one row containing the text 'URL/Keyword' and a 'Select' button. Below the table are two buttons: 'Delete Selected' and 'Delete All'.

At the bottom right of the window, there are two buttons: 'Apply' and 'Cancel'.

## Security Filter

The screenshot shows the 'Security Filter' configuration window. It has a red title bar with the text 'Security Filter'. The main content area is divided into one section:- Web Filter:** A dark header bar. Below it, there is a list of four items, each with an unchecked checkbox to its right:
- Proxy
- Java
- ActiveX
- Cookie

At the bottom right of the window, there is one button: 'Apply'.

The **Security Filter** submenu allows users to use the **Web Filter** feature. This feature allows users to enable up to four specific filtering methods.

Proxy:

Use of WAN proxy servers may compromise the Router's security. Check this option to disable access to any WAN proxy servers.

- 
- Java:** Java is a programming language for websites. Check this option to disable Java. If Java is disabled, users run the risk of not having access to Internet sites created using this programming language.
- ActiveX:** ActiveX is a programming language for websites. Check this option to disable ActiveX. If ActiveX is disabled, users run the risk of not having access to Internet sites created using this programming language.
- Cookie:** A cookie is data stored on the PC and used by Internet sites when users interact with them. Check this option to disable cookies.

## ***Enable***

Enable or disable **NAT** (Network Address Translation) for better network performance



# Port Forwarding

**Port Forwarding**

**Enable Port Forwarding**

Port Forwarding  Enable

**Add Port Rule**

Local IP

Type **Both** ▼

Port Range  -

Comment

**Port Forwarding Table**

Local IP	Type	Port range	Comment	Select
----------	------	------------	---------	--------

The **Port Forwarding** submenu allows users to set port forwarding configurations.

Port Forwarding allows you to set up public services on your network, such as web servers, ftp servers, e-mail servers, and other specialized applications.

## Enable Port Forwarding

**Enable Port Forwarding**

Port Forwarding  Enable

Port Forwarding:

Allows users to enable or disable service provided on their network for external devices to access, such as web servers, ftp servers, e-mail servers, and other specialized Internet applications. Check or uncheck to enable or

---

disable this feature.

## Add Port Rule

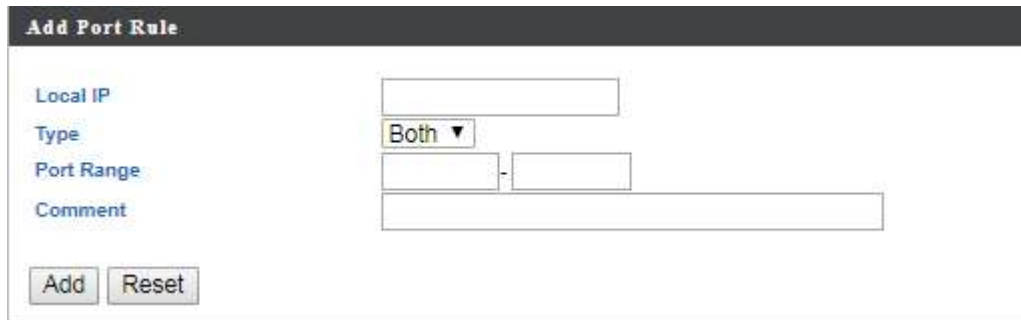

The screenshot shows a form titled "Add Port Rule". It contains the following fields and controls:

- Local IP:** A text input field.
- Type:** A dropdown menu currently showing "Both".
- Port Range:** Two text input fields separated by a hyphen (-).
- Comment:** A text area.
- Buttons:** "Add" and "Reset" buttons at the bottom left.

If the port forwarding function is enabled, follow the instructions below for each field.

- Local IP:** Enter the IP address of the computer running specific applications.
- Type:** Check the drop-down list to select a service type. The available options are: *Both*, *TCP*, and *UDP*.
- Port Range:** Enter the start port number and the end port number to specify the range for port forwarding.
- Comment:** Provide a description of the rule.

Click **Add** to add a rule or **Reset** to reset.

## Port Forwarding Table



The screenshot shows a table titled "Port Forwarding Table". The table has the following columns:

Local IP	Type	Port range	Comment	Select
----------	------	------------	---------	--------

Below the table are two buttons: "Delete Selected" and "Delete All".

This section allows users to manage port forwarding rules. All port forwarding rules you have created will be displayed in this table.

To remove specific rules, select those rules and click **Delete Selected**. To remove all rules, click **Delete All**.

## Visual Server

This function allows you to set up an internet service on a local computer, without exposing the local computer to the internet. You can also build various sets of port redirection, to provide various internet services on different local computers via a single internet IP address.

**Virtual Server**

**Enable Virtual Server**

Virtual Server  Enable

**Add Virtual Server**

Local IP

Local Port

Type **Both** ▼

Public Port

Comment

Add Reset

**Virtual Server Table**

Local IP	Local Port	Type	Public Port	Comment	Select
----------	------------	------	-------------	---------	--------

Delete Selected Delete All

Apply Cancel

<b>Local IP</b>	Specify the IP address of the computer on your local network.
<b>Local Port</b>	Specify the private port you wish to use on the computer in your local network.
<b>Type</b>	Select the type of Internet Protocol.
<b>Public Port</b>	Specify a public port to access the computer on your local network.
<b>Comment</b>	Enter a comment for reference or identification.

## Visual Server Table

Current Virtual Table entries will be displayed in the table shown below

Local IP	Local Port	Type	Public Port	Comment	Select
<input type="button" value="Delete Selected"/> <input type="button" value="Delete All"/>					

<b>Delete Selected/ Delete All</b>	Delete selected or all entries from the table.
--	--

## Special Application

### Special Application

#### Enable Trigger port

Trigger port  Enable

#### Add Trigger port

Popular Applications

Trigger Port  -

Trigger Type

Public Port

Public Type

Comment

#### Trigger port Table

Trigger port	Trigger type	Public Port	Public type	Comment	Select
<input type="button" value="Delete Selected"/> <input type="button" value="Delete All"/>					

The **Special Application** submenu allows users to use the port triggering feature. Port Triggering allows the router to watch outgoing data for specific port numbers. The router remembers the IP address of the



---

computer that sends the matching data, so that when the requested data returns through the router, the data is pulled back to the proper computer by way of IP address and port mapping rules.

## Enable Trigger Port



Trigger Port: Allows users to monitor outgoing data for specific port numbers. Check or uncheck to enable or disable this feature.

## Add Trigger Port

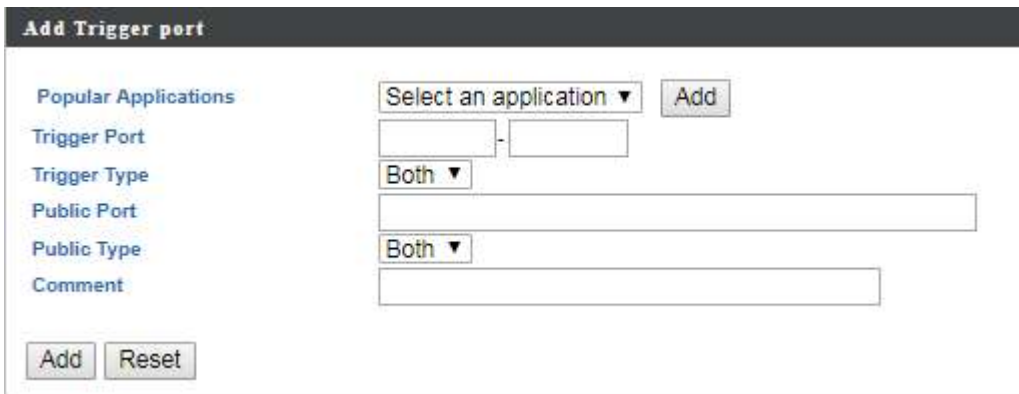

If the port triggering function is enabled, follow the instructions below for each field.

Popular Applications: Click the drop-down list and select an application, then click **Add** next to the drop-down list. After clicking **Add**, all fields relating to this application will be automatically filled. Make sure that all options and parameters in the fields are applicable. If necessary, you are allowed to configure manually. Then click **Add** at the bottom to add this application as a port triggering entry.

Trigger Port: Enter the start port number and the end port number manually for a selected application if necessary.

---

Trigger Type:	Click the drop-down list and select the protocol used for the specific application. The available options are: <i>Both</i> , <i>TCP</i> , and <i>UDP</i> .
Public Port:	Enter the port number manually for a selected application if necessary.
Public Type:	Click the drop-down list and select the protocol used for the specific application. The available options are: <i>Both</i> , <i>TCP</i> , and <i>UDP</i> .
Comment:	Provide a description of an entry.

Click **Add** at the bottom to add a new Trigger Port rule or **Reset** to reset.

## Trigger Port Table



Trigger port	Trigger type	Public Port	Public type	Comment	Select
--------------	--------------	-------------	-------------	---------	--------

This section allows users to manage Trigger Port rules.

To remove specific rules, select those rules and click **Delete Selected**. To remove all rules, click **Delete All**.

## ALG

Enable or disable **ALG** (Application Layer Gateway)

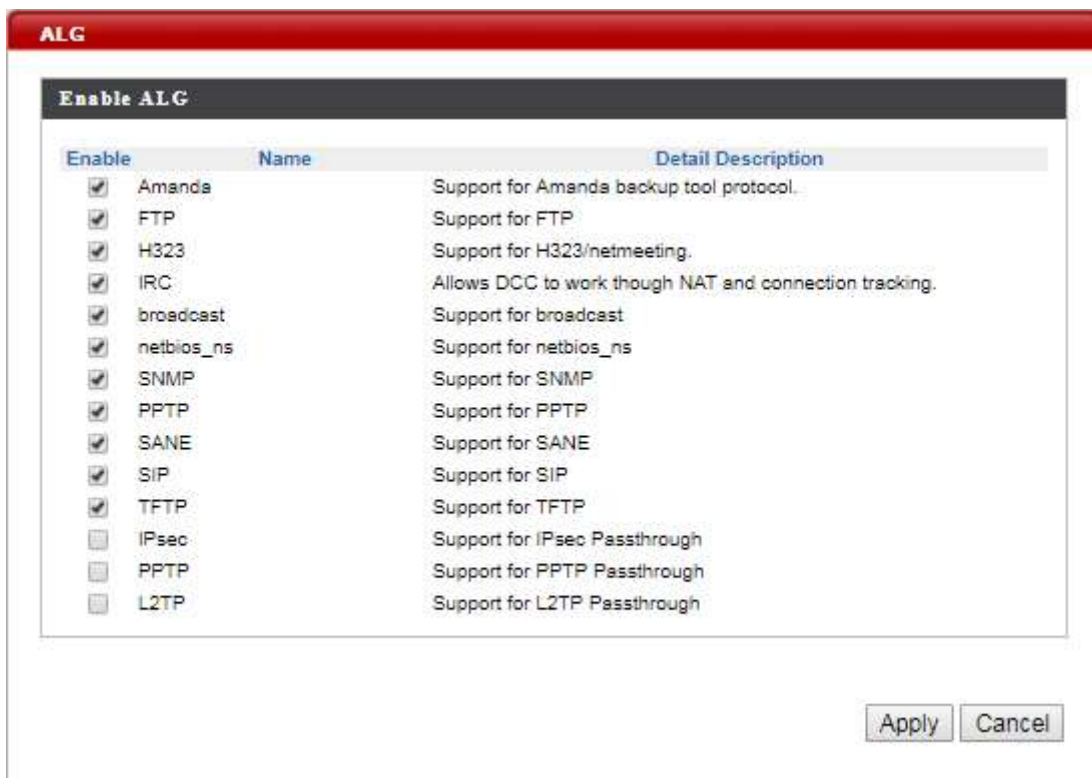

The screenshot shows a window titled "ALG" with a sub-header "Enable ALG". Below the sub-header is a table with three columns: "Enable", "Name", and "Detail Description". The table lists various protocols with checkboxes in the "Enable" column. The "Apply" and "Cancel" buttons are located at the bottom right of the window.

Enable	Name	Detail Description
<input checked="" type="checkbox"/>	Amanda	Support for Amanda backup tool protocol.
<input checked="" type="checkbox"/>	FTP	Support for FTP
<input checked="" type="checkbox"/>	H323	Support for H323/netmeeting.
<input checked="" type="checkbox"/>	IRC	Allows DCC to work though NAT and connection tracking.
<input checked="" type="checkbox"/>	broadcast	Support for broadcast
<input checked="" type="checkbox"/>	netbios_ns	Support for netbios_ns
<input checked="" type="checkbox"/>	SNMP	Support for SNMP
<input checked="" type="checkbox"/>	PPTP	Support for PPTP
<input checked="" type="checkbox"/>	SANE	Support for SANE
<input checked="" type="checkbox"/>	SIP	Support for SIP
<input checked="" type="checkbox"/>	TFTP	Support for TFTP
<input type="checkbox"/>	IPsec	Support for IPsec Passthrough
<input type="checkbox"/>	PPTP	Support for PPTP Passthrough
<input type="checkbox"/>	L2TP	Support for L2TP Passthrough

## UPnP



The screenshot shows a window titled "UPnP" with a sub-header "UPnP". Below the sub-header is a radio button control for "UPnP" with two options: "Enable" and "Disable". The "Disable" option is selected. The "Apply" and "Cancel" buttons are located at the bottom right of the window.

The **UPnP** submenu allows users to enable or disable UPnP (Universal Plug and Play) which allows wired and wireless network devices to identify each other and establish network services.

UPnP:                      Check Enable or Disable to enable or disable UPnP.

Click **Apply** to have any changes to the configurations take effect or **Cancel** to abort.

---

## Dynamic DNS



The **Dynamic DNS** submenu features configuration options for Dynamic DNS (Dynamic Domain Name Service), which is a system that allows the domain name data held in a name server to be updated in real time. It allows an Internet domain name to be assigned to a computer with a varying (dynamic) IP address. For using this feature, users need to sign up for DDNS with a DDNS provider, refer to [www.dyndns.org](http://www.dyndns.org) or [www.TZO.com](http://www.TZO.com).

**Enable:** Allows users to enable or disable Dynamic DNS.

If Dynamic DNS is enabled, follow the instructions below for each field.

**Service:** Specify the Dynamic DNS service URL. Click the drop-down list and select a URL from the list.

**Hostname:** Enter the hostname for a Dynamic DNS account.

**Username:** Enter the username for a Dynamic DNS account.

**Password:** Enter the password for a Dynamic DNS account.

Click **Apply** to have any changes to the configurations take effect.

---

## Remote Access



The screenshot shows a configuration window titled "Remote Access" with a red header. Inside the window, there is a sub-header "Remote Access" in a dark bar. Below this, there are two settings: "Remote Access" with radio buttons for "Enable" and "Disable" (where "Disable" is selected), and "Remote Access Port" with a text input field containing the number "80". An "Apply" button is located at the bottom right of the window.

The **Remote Access** submenu allows users to specify whether or not to allow remote access for this router.

**Remote Access:** Allows users to enable or disable this feature.

If a remote access is enabled, follow the instructions below for each field.

**Remote Access Port:** Enter the port number for the remote access. The default setting is Port 80.

Click **Apply** to have any changes to the configurations take effect.

# WWAN Setting

### WWAN Setting

#### Network Settings

Roaming Connection	<input checked="" type="radio"/> Enable <input type="radio"/> Disable
APN	<input type="radio"/> Auto <input checked="" type="radio"/> Manual
Profile Selection	internet ▾
IP protocol	IPV4 ▾

#### APN Information

APN	Generic
-----	---------

#### APN Profile Settings

*Please enter the APN profile name before you press the Add button.*

<input type="text"/>	Add
----------------------	-----

#### APN Profile Table

Select	APN Profile Name	Profile Setting	Customize
<input type="checkbox"/>	internet	Configured	Edit
<input type="checkbox"/>	Generic	Not Configured	Edit

Delete Selected   Delete All

Apply

The **WWAN Setting** submenu allows users to change WWAN network settings.

Click **Apply** at the bottom of this submenu to have any changes to the configurations take effect.

## Network Setting

#### Network Settings

Roaming Connection	<input checked="" type="radio"/> Enable <input type="radio"/> Disable
APN	<input type="radio"/> Auto <input checked="" type="radio"/> Manual
Profile Selection	internet ▾
IP protocol	IPV4 ▾

---

Roaming Connection: Allows users to enable or disable this feature.

If a roaming connection is enabled, follow the instructions below for each field.

APN: Check Auto to use automatic APN (Access Point Name) profile settings or Manual for the manual choice of APN profile settings for the network.

Profile Selection: Select the APN profile you have created. Profile Selection does not appear if APN is set to Auto.

IP Protocol: Select an IP protocol. The available options are: *IPV4*, *IPV6*, and *IPV4V6*.

## APN Information



APN: Displays current APN information.

---

## APN Profile Settings

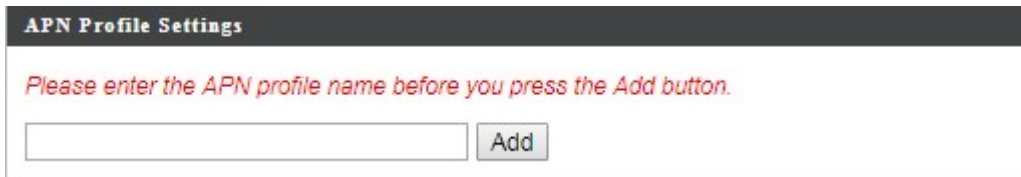

The screenshot shows a form titled "APN Profile Settings". At the top, there is a dark header bar with the title. Below the header, a red italicized message reads: "Please enter the APN profile name before you press the Add button." Underneath this message is a text input field and an "Add" button.

APN Profile Settings: Allows users to establish a new APN profile. Enter a new APN profile name in the field and click **Add** to add a new APN profile. All APN files you have created will be displayed in APN Profile Table.

## APN Profile Table



The screenshot shows a table titled "APN Profile Table". The table has four columns: "Select", "APN Profile Name", "Profile Setting", and "Customize". The first row contains a checkbox, the text "internet", the text "Not Configured", and an "Edit" button. Below the table, there are two buttons: "Delete Selected" and "Delete All".

Select	APN Profile Name	Profile Setting	Customize
<input type="checkbox"/>	internet	Not Configured	Edit

This section allows users to manage APN profile settings.

To remove specific APN profiles, select those profiles and click **Delete Selected**. To remove all profiles, click **Delete All**.

To edit an APN profile, click **Edit**.



## UICC/SIM PIN Management

**UICC/SIM PIN Management**

**USIM Status**

USIM Status      READY

**USIM's PIN Management**

PIN Remain      3

PIN Protection       Enable  Disable

PIN Code       (4~8 digits)

Apply

The **UICC/SIM PIN Management** submenu allows users to manage the SIM card.

### USIM Status

**USIM Status**

USIM Status      READY

**USIM Status:**      Displays current SIM card status of the router. "READY" means that the SIM card is enabled for mobile Internet access.

### USIM's PIN Management

**USIM's PIN Management**

PIN Remain      3

PIN Protection       Enable  Disable

PIN Code       (4~8 digits)

Apply

**PIN Remain:**      Displays how many attempts remain for entering the correct PIN code.

**PIN Protection:**      Check Enable or Disable to enable or disable the PIN code protection.

---

If a PIN protection is enabled, follow the instructions below for each field.

**PIN Code:** Set a PIN code if users do not want the SIM card to be used without permission. Once PIN protection is enabled, every time users start the router with the specific SIM card inserted, users need to enter the PIN code.

Click **Apply** to have any changes to the configurations take effect.

## ***SIM Management***



The **SIM Management** submenu displays the current SIM lock status.

**SIM Lock Status:** “There is no SIM lock” means the SIM card is unlocked.  
If the SIM card is locked for some reason, the SIM Unlock field will appear in the image allowing users to enter the SIM unlock code to unlock it. After entering the SIM unlock code in the field, click **Apply**.

## ***Preferred Network***



---

The **Preferred Network** submenu allows users to select the network type.

Network Type: Displays the current network type. Click the drop-down list to select the preferred mobile network type. The default option is *Auto*. Other available options are *LTE (4G)*, *WCDMA (3G)* and *GSM*.

## ***AT Command***



The **AT Command** submenu displays AT command sets.

# Management

The screenshot displays the Cellferno Management interface. At the top, the Cellferno logo is on the left, and navigation links for Home, Logout, and Global (English) are on the right. Below the logo is a signal strength indicator and 'LTE' text. The main navigation bar includes Status, Network Settings, Management (highlighted), Advanced, and Help. A left sidebar lists Management submenus: Admin (selected), Date and Time, Syslog Server, Ping Test, Traceroute Test, Speedtest, VPN, and SNMP. The main content area is titled 'Admin' and contains two sections: 'Account to Manage This Device' and 'Advanced Settings'. The 'Account to Manage This Device' section has fields for Administrator Name (admin), Administrator Password (masked with dots), and a confirmation field (masked with dots). The 'Advanced Settings' section has fields for Product Name (M600) and Management Protocol (checked for HTTP and HTTPS). Both sections have an 'Apply' button.

The **Management** menu displays several features to manage the router. The associated submenus are: **Admin**, **Date and Time**, and **Syslog Server**.

# Admin

The screenshot shows a web interface titled "Admin" with a red header. It contains two main sections: "Account to Manage This Device" and "Advanced Settings".

**Account to Manage This Device**

- Administrator Name:
- Administrator Password:  (4-32Characters)
- Confirm Password:  (Confirm)
- Apply button

**Advanced Settings**

- Product Name:
- Management Protocol:  HTTP,  HTTPS,  TELNET
- Apply button

The **Admin** submenu allows users to configure administrator settings.

## Account to Manage This Device

This is a close-up of the "Account to Manage This Device" section from the previous screenshot. It shows the "Administrator Name" field with the value "admin", the "Administrator Password" field with "\*\*\*\*" and "(4-32Characters)", and a "Confirm" field with "\*\*\*\*" and "(Confirm)". An "Apply" button is located at the bottom left.

**Administrator Name:** Allows users to configure the administrator account name for the router by entering an account name for an administrator account.

**Administrator Password:** Allows users to configure a password for an administrator account. Enter the password again to confirm the password.

Click **Apply** to have any changes to the configurations take effect.

---

## Advanced Settings

Input the Product Name and Enable or disable Management Portocol



The image shows a configuration window titled "Advanced Settings". It contains a text input field for "Product Name" with the value "AP0026FA0D6D10". Below it, there are three checked checkboxes for "Management Protocol": "HTTP", "HTTPS", and "TELNET". An "Apply" button is located at the bottom left of the window.

## Date and Time

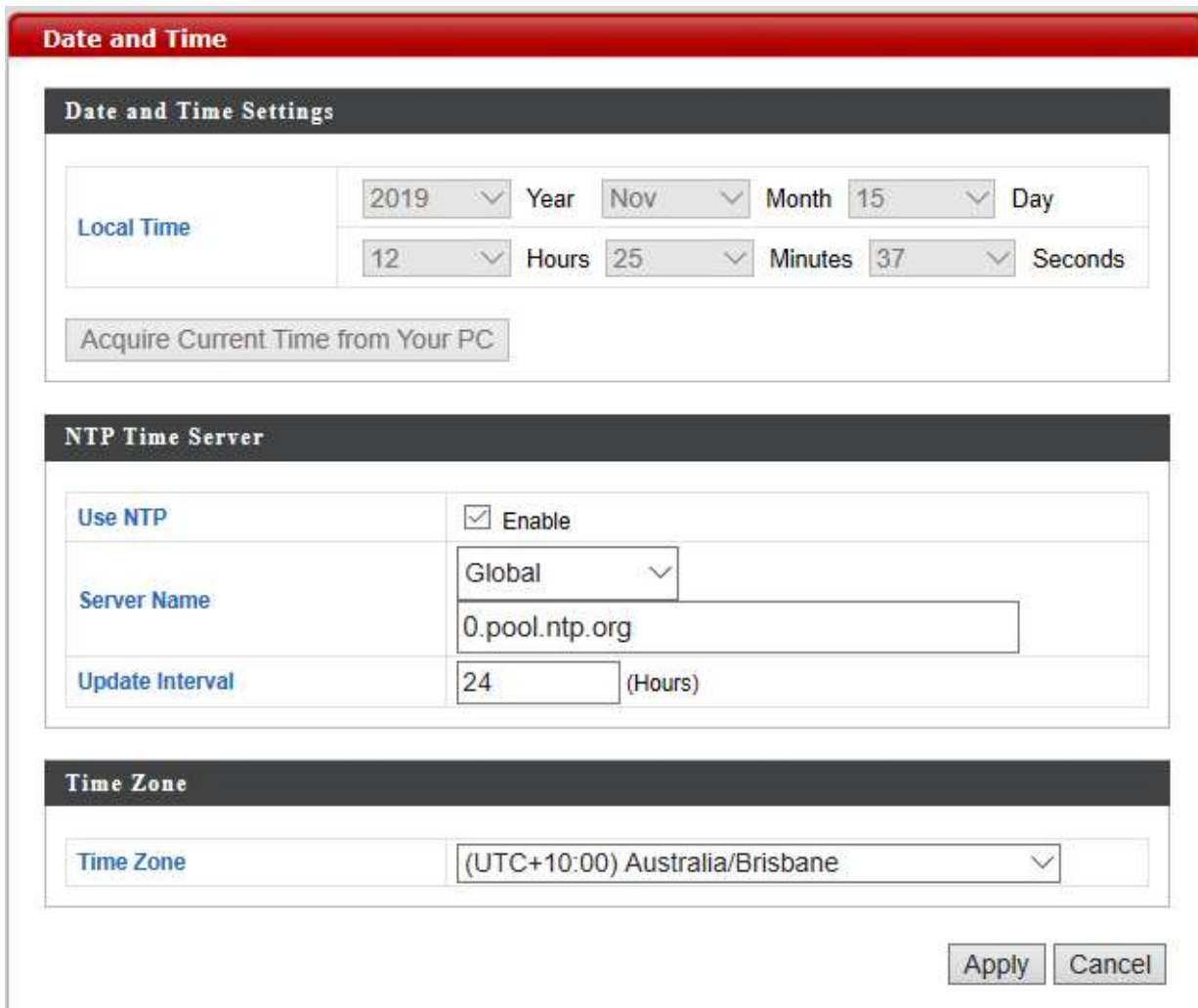

The image shows a configuration window titled "Date and Time" with a red header bar. It is divided into three sections:

- Date and Time Settings:** Contains a "Local Time" section with dropdown menus for Year (2019), Month (Nov), Day (15), Hours (12), Minutes (25), and Seconds (37). Below this is a button labeled "Acquire Current Time from Your PC".
- NTP Time Server:** Contains a "Use NTP" checkbox which is checked and labeled "Enable". Below it is a "Server Name" section with a dropdown menu set to "Global" and a text input field containing "0.pool.ntp.org". Below that is an "Update Interval" section with a text input field containing "24" and the label "(Hours)".
- Time Zone:** Contains a "Time Zone" dropdown menu set to "(UTC+10:00) Australia/Brisbane".

At the bottom right of the window, there are two buttons: "Apply" and "Cancel".

The **Date and Time** submenu allows users to configure the date and time settings.

---

## Date and Time Settings

**Date and Time Settings**

Local Time: 2016 Year Dec Month 1 Day  
0 Hours 00 Minutes 00 Seconds

Acquire Current Time from Your PC

**Local Time:** Displays current local time. It allows users to set the date and time manually by clicking the drop-down lists or clicking **Acquire Current Time from Your PC** to fill the fields automatically using the date and time of their computers.

## NTP Time Server

**NTP Time Server**

Use NTP  Enable

Server Name User-Defined

Update Interval 24 (Hours)

**Use NTP:** Check or uncheck to enable or disable NTP (Network Time Protocol) client.

If a NTP is enabled, follow the instructions below for each field.

**Server Name:** Select the preferred NTP server from the drop-down list or enter the desired server candidates in the field after enabling the Use NTP function.

**Update Interval:** Set update frequency. The field is greyed out if Use NTP is not enabled.

## Time Zone

**Time Zone**

Time Zone (GMT+08:00) Taipei, Taiwan

---

Time Zone:

Click the drop-down list and select the desired time zone.

## ***Syslog Server***

Enable or disable Syslog Server.



The screenshot shows a dialog box titled "Syslog Server" with a red header bar. Inside the dialog, there is a section titled "Syslog Server Settings" with a dark background. Below this, there is a "Transfer Logs" link on the left. To the right of the link is a checkbox labeled "Enable Syslog Server", which is currently unchecked. Below the checkbox is a light gray rectangular field. At the bottom right of the dialog, there are two buttons: "Apply" and "Cancel".



# Advanced

The **Advanced** menu displays **Update Firmware**, **Save/Restore Settings**, **Factory Default**, **Reboot**, and **Help**.

The screenshot shows the Cellferno web interface. At the top left is the Cellferno logo. To the right are links for Home, Logout, and a language dropdown set to Global (English). Below this is a navigation bar with tabs for Telstr, Status, Network Settings, Management, **Advanced**, and Help. On the left side of the Advanced page is a sidebar menu with options: Update Firmware (selected), Save/Restore Settings, Factory Default, and Reboot. The main content area is titled 'Update Firmware' and contains four sections: 1. 'Firmware Location' with a radio button selected for 'a file on your PC'. 2. 'Update Firmware from PC' with a text input for 'Firmware Update File (\*.bin)', a 'Browse...' button, and an 'Update' button. 3. 'LTE Module Firmware' with a text input for 'Firmware Update File (\*.mod)', a 'Browse...' button, and an 'Update' button. 4. 'Customize Settings' with a text input for 'Upload (\*.cmr)', a 'Browse...' button, and an 'Update' button.

---

## Update Firmware

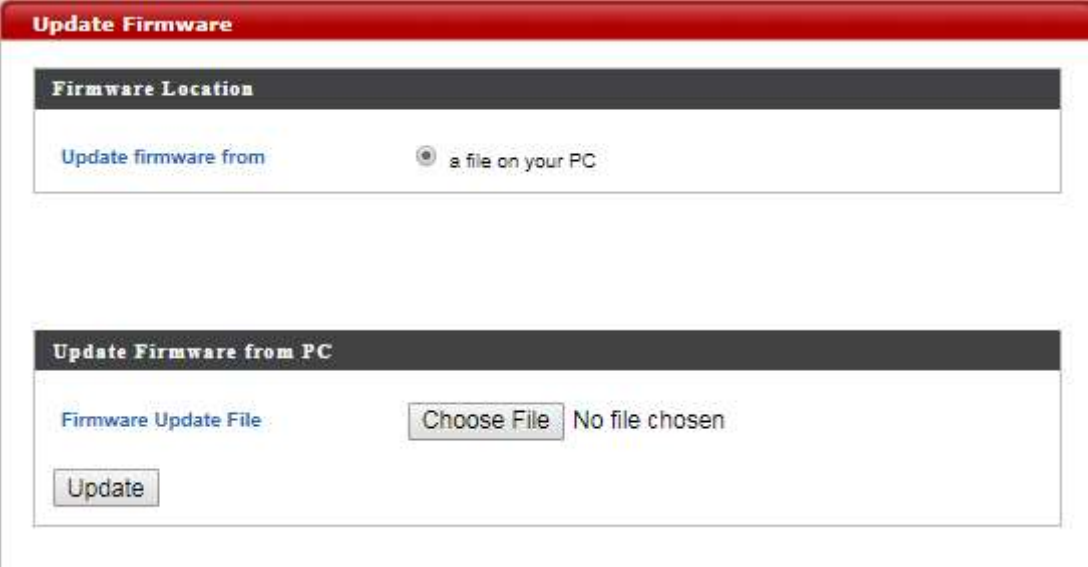

The screenshot shows a web interface for updating firmware. It is divided into two main sections. The top section, titled "Firmware Location", contains a link "Update firmware from" and a radio button selected for "a file on your PC". The bottom section, titled "Update Firmware from PC", contains a link "Firmware Update File", a "Choose File" button, and the text "No file chosen". Below this is an "Update" button.

The **Update Firmware** submenu allows users to update the firmware for the router.

### Firmware Location

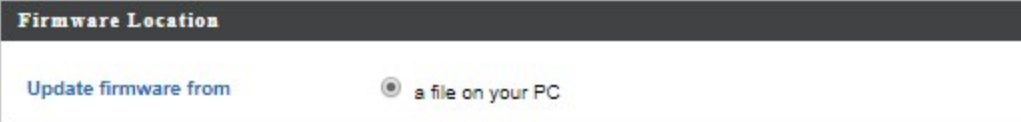

This close-up shows the "Firmware Location" section. It features a link "Update firmware from" and a radio button selected for "a file on your PC".

This section allows users to choose where the firmware update file is located.

### Update Firmware from PC

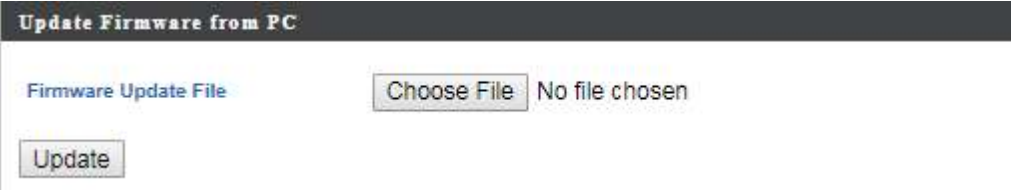

This close-up shows the "Update Firmware from PC" section. It features a link "Firmware Update File", a "Choose File" button, the text "No file chosen", and an "Update" button.

This section allows users to update the router with the latest firmware.

Click **Choose File** to browse and select the firmware package file, and then click **Update**. Once the firmware has been updated successfully, the router will restart.



**Warning:** Updating firmware may take a few minutes. Do NOT turn off the power or press the Reset button during the update process.

## Save/Restore Settings

The screenshot shows the 'Save/Restore Settings' web interface. It has a red header bar with the title 'Save/Restore Settings'. Below the header, there are three main sections:

- Save/Restore Method:** A section with two radio button options: 'Using Device' (unselected) and 'Using your PC' (selected).
- Save Settings to PC:** A section with a 'Save Settings' link, a checkbox for 'Encrypt the configuration file with a password' (unchecked), a text input field, and a 'Save' button.
- Restore Settings from PC:** A section with a 'Restore Settings' link, a 'Choose File' button, the text 'No file chosen', a checkbox for 'Open file with password' (unchecked), a text input field, and a 'Restore' button.

The **Save/Restore Settings** submenu allows users to save and restore the current router settings.

### Save/Restore Method

This screenshot shows the 'Save/Restore Method' section of the interface. It features a dark header bar with the title 'Save/Restore Method'. Below the header, there are two radio button options: 'Using Device' (unselected) and 'Using your PC' (selected).

This section allows users to choose where the router's settings will be saved or restored from.

---

## Save Settings to PC

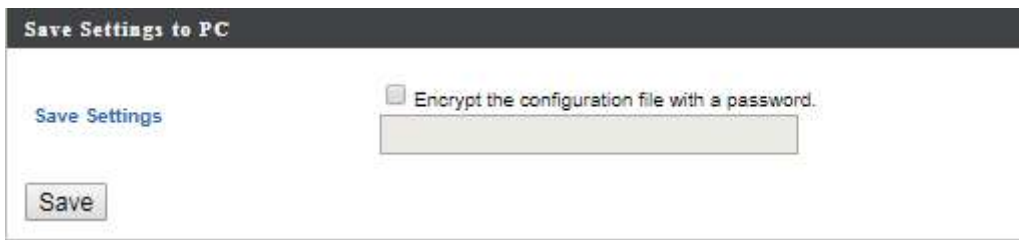

The screenshot shows a web interface titled "Save Settings to PC". On the left, there is a blue link labeled "Save Settings". Below it is a grey button labeled "Save". On the right side, there is a checkbox labeled "Encrypt the configuration file with a password." which is currently unchecked. Below the checkbox is a text input field.

Users can save all current settings of the router to a TAR archive file on their computers.

Router settings can be protected by a password. Check **Encrypt the configuration file with a password**, enter a password in the field then click **Save** to save the router settings. Once the encryption is enabled, every time users want to restore the specific settings, users need to enter the password.

If protection is not needed, just click **Save** to save the settings.

## Restore Settings from PC

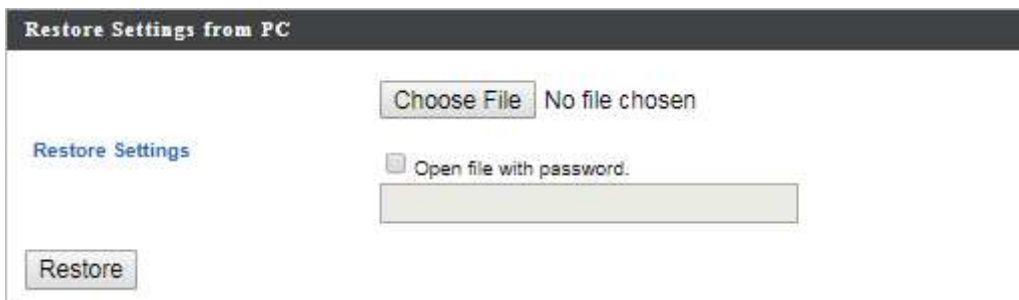

The screenshot shows a web interface titled "Restore Settings from PC". On the left, there is a blue link labeled "Restore Settings". Below it is a grey button labeled "Restore". On the right side, there is a "Choose File" button followed by the text "No file chosen". Below that is a checkbox labeled "Open file with password." which is currently unchecked. Below the checkbox is a text input field.

Users can restore router settings previously saved as a TAR archive file on their computers.

Click **Choose File** to find and select the desired TAR archive file and click **Restore**. The system will restart after the restoration process has been finished. If a TAR archive file is encrypted, users need to enter the password before the settings can be restored.

---

## Factory Default



Click **Factory Default** to restore the router to its original factory settings. When clicking **Factory Default**, a dialog box will appear to indicate the reset process. Follow the instructions to restart and return the router to its initial settings.

## Reboot



Click **Reboot** to restart the router.

## Help



Click **Download** to download the latest Quick Start Guide or User Manual of this router.

---

# Appendix A: FAQ

Appendix A contains a list of frequently asked questions when you set up your CPE configuration.

## **Q: What is an IP address and how do I find my computer IP address?**

**A:** IP address is the identifier for a computer or device on a TCP/IP network. Networks using the TCP/IP protocol route messages based on the IP address of the destination. The format of an IP address is a 32-bit numeric address written as four numbers separated by periods. Each number can be zero to 255.

For example, 192.168.168.254 could be an IP address.

To find your computer IP address,

- In Windows, click **Start > Run** to launch the **Command** program.
- Type "ipconfig", then press the **Enter** button.
- Your computer IP address is listed on the IP Address.

## **Q: What is Long Term Evolution (LTE)?**

**A:** LTE is a 4th generation (4G) mobile broadband standard and is the successor to the 3G technologies CDMA/GSM/UMTS. The service is typically much faster on both uplink/download speeds.

## **Q: What is a firewall?**

**A:** A firewall is a set of related programs that protects the resources of a private network from users from other networks.

## **Q: What is Network Address Translation (NAT)?**

---

**A:** Network Address Translation (NAT) is the process where a network device, usually a firewall, assigns a public address to a computer (or group of computers) inside a private network.

**Q: What is Universal Plug and Play (UPnP)?**

**A:** UPnP is an open networking architecture that consists of services, devices, and control points. The ultimate goal is to allow data communication among all UPnP devices regardless of media, operating system, programming language, and wired/wireless connection.

---

# Appendix B: Specifications

*NOTE: Specifications are subject to change without notice.*

<b>Physical</b>	
Cellular Modem	Embedded, 3GPP Rel 10, LTE Advance FDD&TDD
Dimensions	247 (L) x 247 (W) x 107 (H) mm
Weight	1.5kg
Water Resistant IP Code	IP66
<b>Interface</b>	
Ethernet Port	RJ45 x 1, with power riding on Ethernet cable
SIM Card	1 x SIM slot for external 2FF SIM plug-in with sealing protection
Reset Button	Reset to factory default setting
LED Indicator	Signal strength indicator x 2 Signal indicator x 1 Power indicator x 1
<b>Connectivity and Data Speed</b>	
LTE Bands	M600 1,3,5,7,8,18,19,21,28,38,39,40,41  M1200 1,2,3,4,5,7,8,9,12,13,18,19,20,26,28,29,30,41,42,43,46,48,66
LTE Bandwidth	M600 - Up to 40 MHz (2 CA)  M1200 - Up to 60 MHz (3 CA)
LTE Data Rate	M600 Downlink up to 300 Mbps, Uplink up to 50 Mbps  M1200 Downlink up to 600 Mbps, Uplink up to 150 Mbps



WCDMA Band	B1, B5, B6, B8, B9, B19
WCDMA Rate	Downlink: 42 Mbps Uplink: 5 Mbps
<b>Antenna</b>	
Antenna Type	Embedded tri-band directional antenna



Antenna Gain	Refer to Appendix C.
Cellular Main Antenna	Yes
Cellular Diversity Antenna	Yes
LTE MIMO	M600: Downlink 2x2 M1200: Downlink 4x4
<b>Router Features</b>	
Security	Multiple VPN pass-through (IPSec, PPTP, L2TP), Stateless and SPI Firewall, Internet Filter, Web Filter
NAT-NAPT	Single Port Forwarding, Port Range Forwarding, Port Range Triggering, Port Filtering, IP Filtering, DMZ, UPnP, Multicast Pass-Through
DNS	DNS Agent, DDNS
Other Features	IPv4 and IPv6, TCP, UDP, ICMP, ARP, DHCP Server/Client, DHCP Reservation, HTTP/HTTPS, NTP, ALGs
<b>Software Features</b>	
CPE Operation Mode	Router mode
Connection Status in Web GUI	Network name, Signal strength, Roaming indication, Radio technology, Radio network parameters, Connection status, Connection time, Connection Statistics
Connection Management	Connection on demand, Auto Connection, Auto APN matching with USIM, APN database update through browser-based GUI, APN profile, PIN management, Preferred radio network type selection
Support FW Version Upgrade	Yes
Device Management	TR-069, SNMP, Remote GUI Log-in
System Protection	Two types of user account: User and Operator Every user account has separate password protection mechanism
Browser-based Administration GUI	Browser supported: IE, Firefox, Safari, Chrome

Browser-based Administration GUI Multi-Language Support	English
<b>Power Input</b>	
Passive Power over Ethernet (PPoE)	48V Passive PoE input power
<b>Accessories</b>	
Passive Power over Ethernet Adapter	RJ-45 x 2 (Data In x 1, Data & Power Out x 1)
	48V/1A
Mounting Bracket	Fixture (match to the back design) and screws (for mounting on pole and wall) Left-right rotatable
30-meter Ethernet Cable (Optional)	Outdoor grade Ethernet cable with water-proof RJ-45 head at one end
15-meter Ethernet Cable (Optional)	Outdoor grade Ethernet cable with water-proof RJ-45 head at one end
<b>Environment</b>	
Operation Temperature (Excluding Power Adaptor)	-40°C to 65°C (-40°F to 149°F)
Power Adaptor Operation Temperature	0°C to 40°C (32°F to 104°F)
Storage Temperature	-40°C to 70°C (-40°F to 158°F)
Operating Humidity	5% to 90% Non-Condensing
Storage Humidity	5% to 95% Non-Condensing
<b>Certification and Conformance</b>	
Australia	RCM

---

# Appendix C: Antenna Gain

*NOTE: Specifications are subject to change without notice.*

Frequency (MHz)	<b>698</b>	<b>750</b>	<b>824</b>	<b>880</b>	<b>900</b>	<b>960</b>
Peak Gain (dBi)	5.68	4.84	4.14	4.57	6.1	6.48
Frequency (MHz)	<b>1710</b>	<b>1880</b>	<b>1990</b>	<b>2100</b>	<b>2170</b>	<b>2200</b>
Peak Gain (dBi)	7.64	7.08	6.48	7.5	6.56	6.37
Frequency (MHz)	<b>2300</b>	<b>2400</b>	<b>2500</b>	<b>2600</b>	<b>2700</b>	
Peak Gain (dBi)	7.34	7.51	7.92	8.27	8.84	

# ***Appendix D: Important Safety Information and Glossary***

## **Europe – EU Declaration of Conformity**



### **European Union Notice**

Products with CE marking comply with the R&TTE Directive (99/5/EC), the EMC Directive (2004/108/EC), and the Low Voltage Directive (2006/95/EC) issued by the Commission of the European Community.

Compliance with these directives implies conformity to the following European Norms (in parentheses are the equivalent international standards).

### **EN 60950-1 (IEC 60950-1)**

Safety of Information Technology Equipment.

### **EN 300 328**

Electromagnetic compatibility and Radio spectrum Matters (ERM); Wideband Transmission systems; data transmission equipment operating in the 2.4 GHz ISM band and using spread spectrum modulation techniques.

### **EN 301 489-24**

Electromagnetic compatibility and Radio spectrum Matters (ERM);

Electromagnetic Compatibility (EMC) standard for radio equipment and services;

---

Part 24: Specific conditions for IMT-2000 CDMA direct spread (UTRA) for mobile and portable (UE) radio and ancillary equipment.

### **ETSI EN 301 511**

Global system for mobile communications (GSM); Harmonised EN for mobile stations in the GSM 900 and GSM 1800 bands, covering essential requirements of article 3.2 of the R&TTE directive (1995/5/EC).

### **ETSI EN 301 489-1**

Electromagnetic compatibility and Radio spectrum Matters (ERM);

Electromagnetic Compatibility (EMC) standard for radio equipment and services; Part 1: Common technical requirements.

### **ETSI EN 301 489-7**

Electromagnetic compatibility and Radio spectrum Matters (ERM);

Electromagnetic Compatibility (EMC) standard for radio equipment and services;

Part 7: Specific conditions for mobile and portable radio and ancillary equipment of digital cellular radio telecommunications systems (GSM and DCS).

### **ETSI EN 301 489-17**

Electromagnetic compatibility and Radio spectrum Matters (ERM);

Electromagnetic Compatibility (EMC) standard for radio equipment and services;

Part 17: Specific conditions for 2.4 GHz wideband transmission systems.

### **ETSI EN 301 908-1 & -2**

Electromagnetic compatibility and Radio spectrum Matters (ERM); Base Stations (BS), Repeaters and User Equipment (UE) for IMT-2000 Third Generation cellular networks; Part 1: Harmonised EN for IMT-2000, introduction and common requirements, covering essential requirements of article 3.2 of the R&TTE Directive.

---

## **EN 50385**

Product standard to demonstrate the compliance of radio base stations and fixed terminal stations for wireless telecommunication systems with the basic restrictions or the reference levels related to human exposure to radio frequency electromagnetic fields (110 MHz - 40 GHz) - General public.

# **Federal Communication Commission Interference Statement**

15.21

You are cautioned that changes or modifications not expressly approved by the part responsible for compliance could void the user's authority to operate the equipment.

15.105(b)

## **Federal Communications Commission (FCC) Statement**

This equipment has been tested and found to comply with the limits for a Class B digital device, pursuant to part 15 of the FCC rules. These limits are designed to provide reasonable protection against harmful interference in a residential installation. This equipment generates, uses and can radiate radio frequency energy and, if not installed and used in accordance with the instructions, may cause harmful interference to radio communications. However, there is no guarantee that interference will not occur in a particular installation. If this equipment does cause harmful interference to radio or television reception, which can be determined by turning the equipment off and on, the user is encouraged to try to correct the interference by one or more of the following measures:

- Reorient or relocate the receiving antenna.
- Increase the separation between the equipment and receiver.
- Connect the equipment into an outlet on a circuit different from that to which the receiver is connected.



---

- Consult the dealer or an experienced radio/TV technician for help.

**This device complies with Part 15 of the FCC Rules. Operation is subject to the following two conditions:**

- 1) This device may not cause harmful interference and
- 2) This device must accept any interference received, including interference that may cause undesired operation of the device.

**FCC RF Radiation Exposure Statement:**

1. This Transmitter must not be co-located or operating in conjunction with any other antenna or transmitter.
  
2. This equipment complies with FCC RF radiation exposure limits set forth for an uncontrolled environment. This equipment should be installed and operated with a minimum distance of 20 centimeters between the radiator and your body.

---

# Glossary

**2G:** Second-generation mobile networking technology. Represents a switchover from analog to digital; most 2G networks use GSM.

**3G:** Third-generation mobile networking technology that enables simultaneous transfer of voice and non-voice data; most 3G networks use WCDMA.

**3.5G:** A more recent standard of mobile networking technology; generally uses HSDPA.

**3.75G:** A more recent standard of mobile networking technology; generally uses HSUPA.

**4G:** A more recent standard of mobile networking technology; generally uses LTE.

**APN (Access Point Name/Network):** Provides GPRS routing information. Consists of:

Network ID: Identifies the external service requested by a GPRS user.

Mobile network operator ID: Specifies routing information.

**bps (bits per second):** How data flow is measured.

**DNS (Domain Name System):** Helps route network traffic by making the addressing process more user-friendly.

**DHCP (Dynamic Host Configuration Protocol):** How devices obtain IP addresses from a server.

**DUN (Dial-Up Network):** Windows component that enables online access via a modem.

**EDGE (Enhanced Data GSM Environment/Enhanced Data for Global Evolution):** Advanced GPRS that delivers multimedia and other data needing greater bandwidth at up to 237 kbps.

**GPRS (General Packet Radio Service):** Delivers data in packets at up to 86 kbps.

**GSM (Global System for Mobile Communications):** The most popular cellular network, mostly operates in 850-900 or 1800-1900 MHz; the primary 2G system.

**HSDPA (High Speed Downlink Packet Access):** Advanced WCDMA that delivers downlink bandwidth intensive data at up to 7.2Mbps; typically associated with 3.5G.

**HSUPA (High Speed Uplink Packet Access):** Advanced WCDMA that delivers uplink bandwidth intensive data at up to 5.76Mbps; typically associated with 3.75G.

**HSPA+ (High Speed Packet Access +):** This is also known as HSPA Evolved, is the next step and is more focused on delivering data services enabling speeds of up to 42Mbps in the downlink and 11Mbps in the uplink.

---

**IMEI (International Mobile Equipment Identity):** A number unique to each GSM/UMTS device that can be used block network access by a stolen mobile device.

**IP (Internet Protocol):** Routes packets over a network.

**Kbps (Kilobits per second):** A data flow measure; 1024 bits/second.

**LAN (Local Area Network):** A data network with limited range but good bandwidth.

**Mbps (Megabits per second):** A data flow measure; 1,048,576 bits/second.

**LTE (Long Term Evolution):** High-speed mobile communication standard based on the GSM/EDGE and UMTS/HSPA network technologies. LTE provides downlink peak rates up to 300 Mbit/s and uplink peak rates up to 75 Mbit/s.

**PAP (Password Authentication Protocol):** The difference between PAP authentication and a manual or scripted login, is that PAP is not interactive. The username and password are entered in the client's dialing software and sent as one data package as soon as the modems have established a connection, rather than the server sending a login prompt and waiting for a response.

**PPP (Point-to-Point Protocol):** An internet connection method.

**PIN (Personal Identity Number):** Four to eight digital numbers SIM card security code; allows access to the carrier's network.

**Rx:** Shorthand for Reception.

**SIM (Subscriber Identity Module):** A small card that contains key mobile device identification, subscription and contact information.

**Tx:** Shorthand for Transmission.

**WCDMA (Wideband Code Division Multiple Access):** Advanced EDGE that supports 384kbps data flow. Most 3G networks use this standard, the same as UMTS.

**Cellferno is distributed and a Trademark of:**

**Powertec Telecommunications Pty Ltd**

**16/511 Olsen Avenue**

**Southport Qld 4214**

**Australia**

**Ph: +61 7 5577 0500 – Email: [sales@powertec.com.au](mailto:sales@powertec.com.au)**